

K7-12 (600)

No	a*b	X
2	716x298	2
3	568x300	2
4	568x290	1
5	720x300	1
6	720x300	1
7	716x297	1
8	716x297	1

K7-12 (800)

No	a*b	X
2	716x398	2
3	768x300	2
4	768x290	1
5	720x300	1
6	720x300	1
7	716x397	1
8	716x397	1

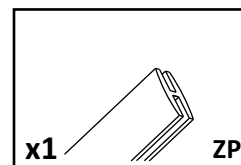
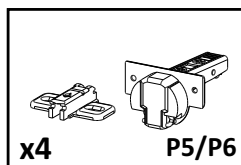
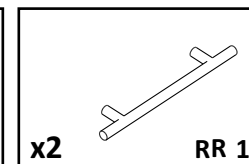
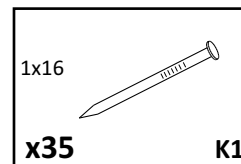
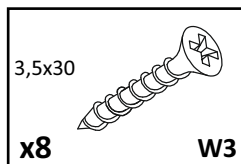
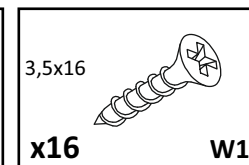
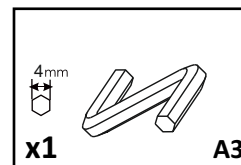
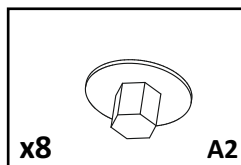
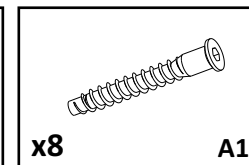
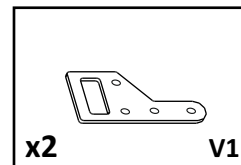
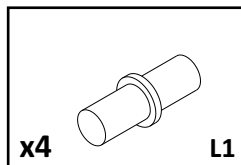

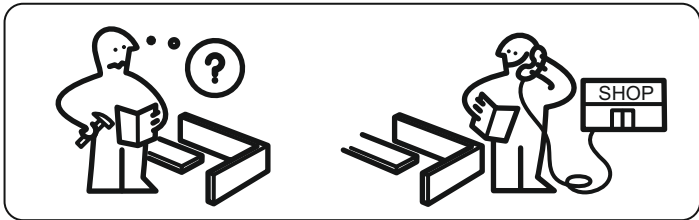
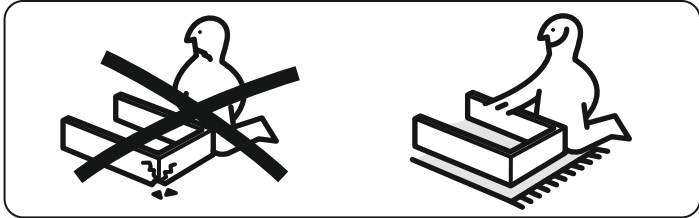
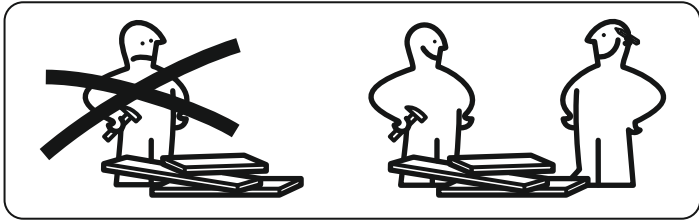

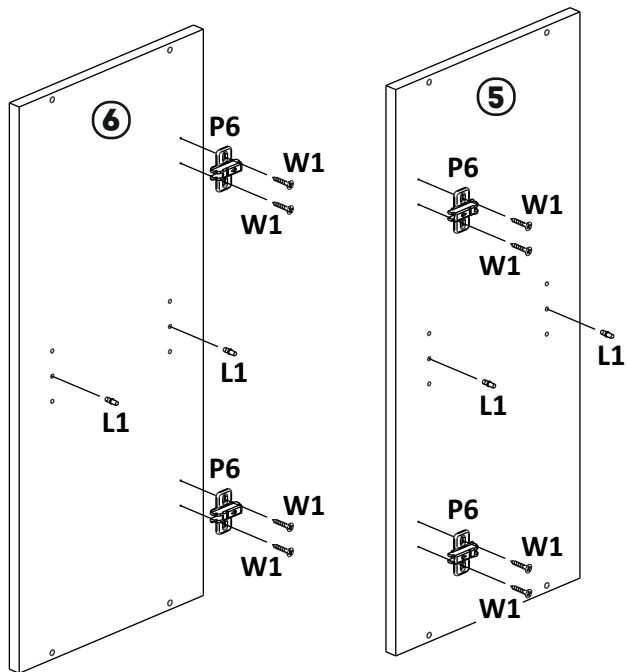
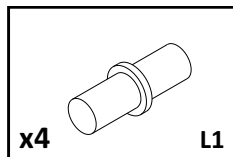
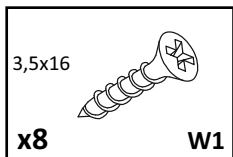
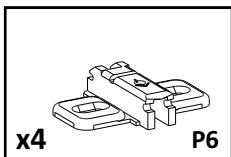
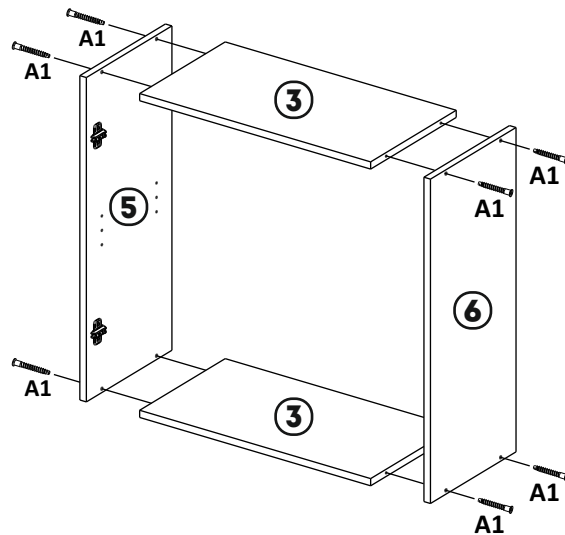
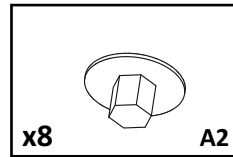
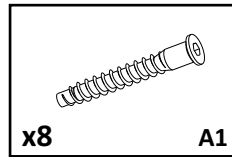
1**2**

3

1x16

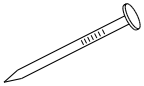
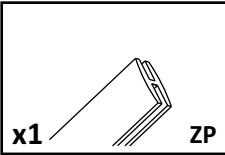
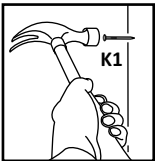
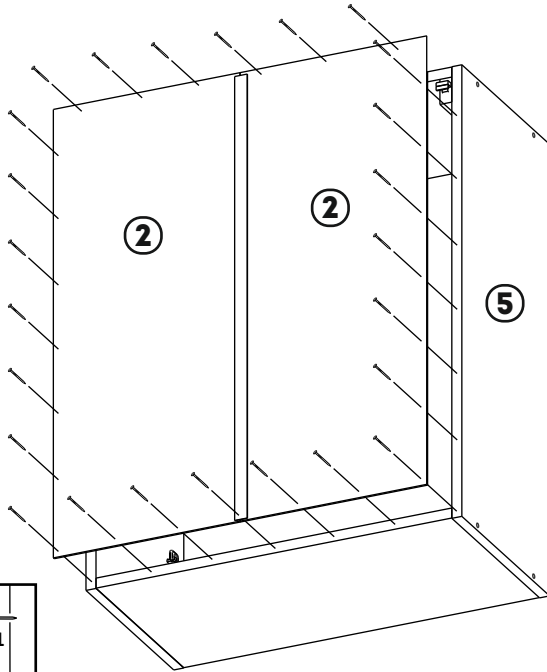
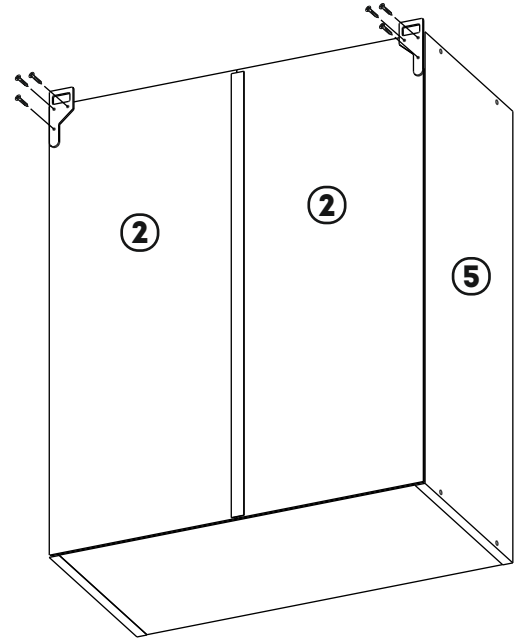
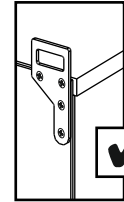
**x35****K1****x1****ZP****4**W1 (x3)
W3 (x1)**V1**

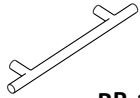
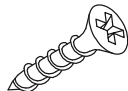
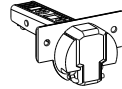
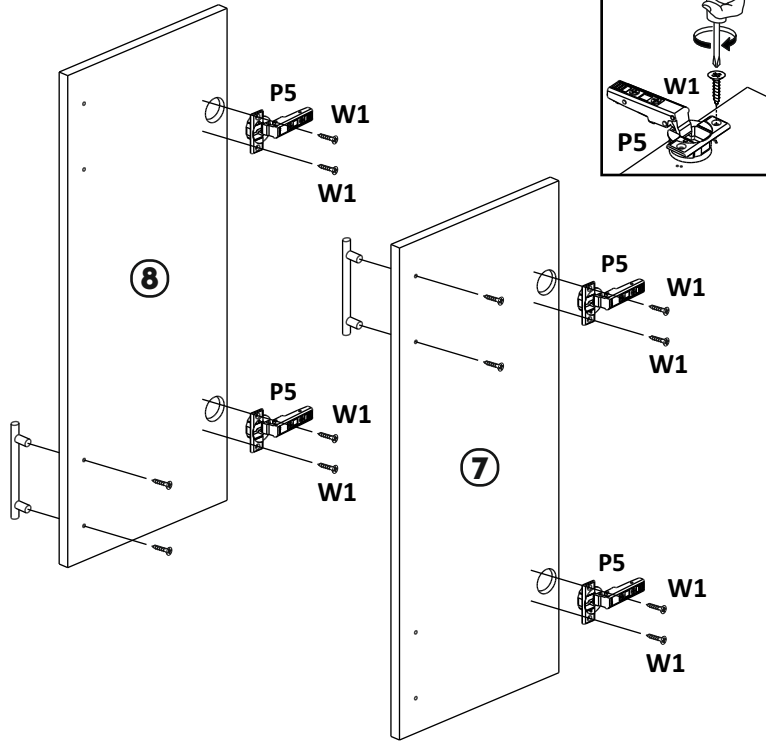
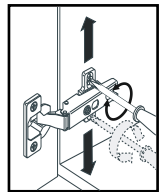
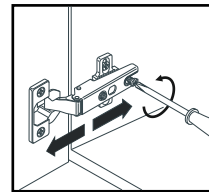
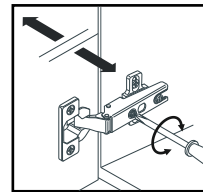
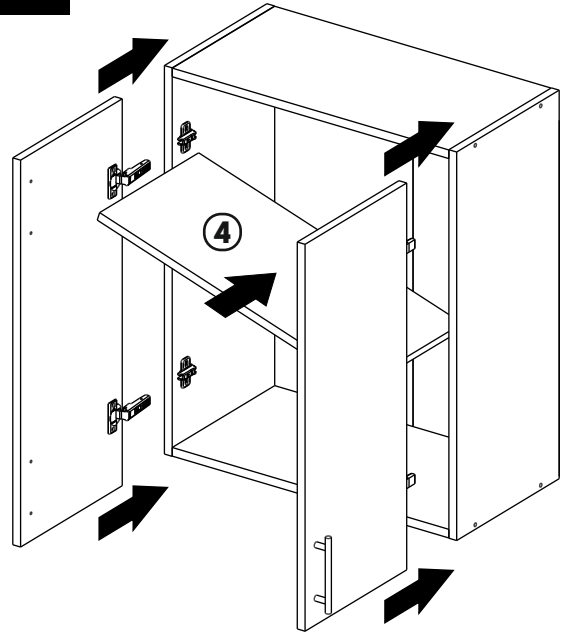
5**x2****RR 1****3,5x16****x8****W1****x4****P5****6****7**